

Varenummer: 339711190000
Beskrivelse: Multibeam 6 kobling 711.19.0000
Acetal og Klemme (Clamp)

Mål

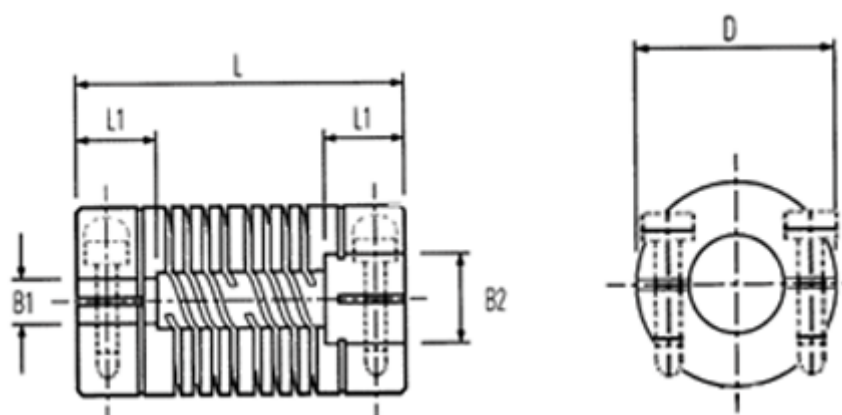

B2: Forboret	= 4.0	Pinolskrue	= M2,5
B2: Forboret	= 6.35	Spidsmoment NM	= 1.30
D	= 19.1		
L	= 26.5		
L1	= 6.5		
Maks. B1 & B2	= 9.53		
Max parallelforskydning	= 7		
Max vinkelforskydning	= 0.25		